

# OPERATING INSTRUCTIONS & SERVICE MANUAL

SOLID-STATE STEREO AMPLIFIER

## SANSUI AU-555A

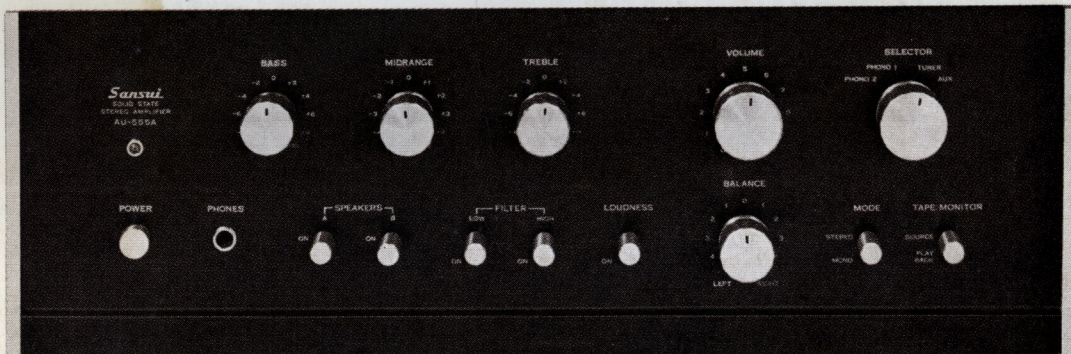

**Sansui**

SANSUI ELECTRIC COMPANY LIMITED



Thank you for selecting the Sansui AU-555A Solid State Stereo Control Amplifier, upgraded model of the AU-555, featuring the refined dull black panels and the exclusive Triple Tone Controls. We sincerely feel that you've made the best choice possible in the compact size and medium power amplifier field. In design, appearance and performance, the AU-555A draws heavily on the careful engineering that has made Sansui's larger AU-amplifiers favorites among stereo enthusiasts throughout the world. Like every Sansui audio component, the model AU-555A was inspected and certified to be in perfect operating condition before leaving our factory.

This manual has been prepared to help you keep it that way by covering the correct procedures for installation, connecting components and operating controls. For years of trouble-free stereo enjoyment, please read it carefully before operating the amplifier.

## CONTENTS

### OPERATING INSTRUCTIONS

SWITCHES AND CONTROLS .....	3, 4
OPERATIONS .....	5, 6
—SPEAKER CONNECTIONS	
—RECORD PLAYING	
OPERATIONS .....	7, 8
—RADIO RECEPTIONS	
—TAPE PLAYING	
ELECTRONIC CROSSOVER SYSTEM.....	9, 10
MAINTENANCE .....	11, 12
SPECIFICATIONS/ACCESSORIES.....	13
CHARACTERISTICS .....	14
<b>SERVICE MANUAL</b>	
TROUBLESHOOTING CHART .....	15, 16
DISASSEMBLY PROCEDURE/TEST POINT.....	17
ALIGNMENT .....	18
BLOCK DIAGRAM.....	19
PRINTED CIRCUIT BOARDS AND PARTS LIST	
.....	20, 21, 22, 23, 24
OTHER PARTS AND THEIR POSITION ON CHASSIS	
.....	25, 26

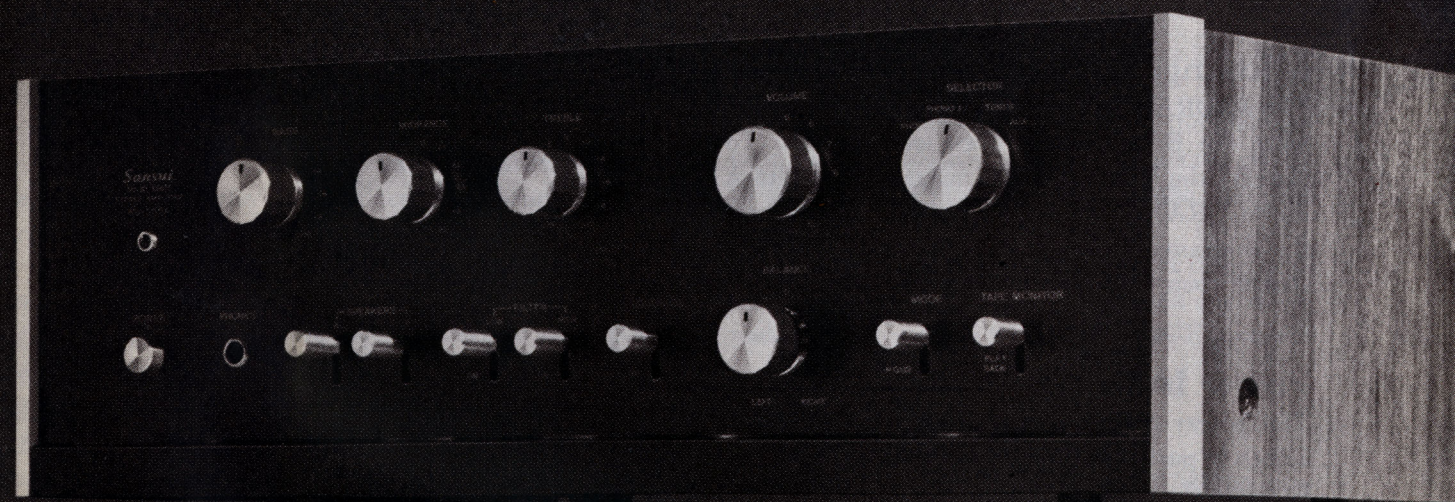



# SWITCHES AND CONTROLS

## Bass Control

The BASS control is used to boost or to cut the low-end response, according to your taste, speaker response and listening conditions. With the BASS control in the mid-position (marked 0), the bass tone will sound exactly as recorded or broadcast. To increase the intensity of the bass tones, turn the BASS control clockwise. To decrease the bass loudness, turn the BASS control counterclockwise.

## Treble Control

The TREBLE control does for the high frequencies what the BASS control does for the lows. To increase the intensity of the treble tones, turn the TREBLE control clockwise. To decrease the treble loudness, turn the TREBLE control counterclockwise.

## Midrange Control

The MIDRANGE control does for the midrange what the BASS control does for the lows. To increase the intensity of the midrange tones, turn the MIDRANGE control clockwise. To decrease the midrange loudness, turn the MIDRANGE control counterclockwise.

## Power Indicator

The power indicator glows when the POWER switch is pushed on. The indicator lamp remains lit while the amplifier is on.

## Power Switch

Power is applied to the amplifier when the POWER switch is pushed. To turn off, push the POWER switch again. The rear AC outlet marked SWITCHED is controlled by this switch.

## Headphones Jack

Plug in a headset for private listening or monitoring. The PHONES jack will accept any standard stereo phono plug but a dynamic headset is recommended.

## Speaker Selector Switches

These switch enables you to choose between one set of speakers ("A" system) and another set ("B" system), which may be installed in the same room or in another part of the house. For private listening with headphones, set both switches to the OFF position.

## Low Filter Switch

The LOW FILTER is used to reduce turntable rumble or other low-frequency noises.

## High Filter Switch

This FILTER is used to reduce record scratch, tape hiss or other high-frequency noises.

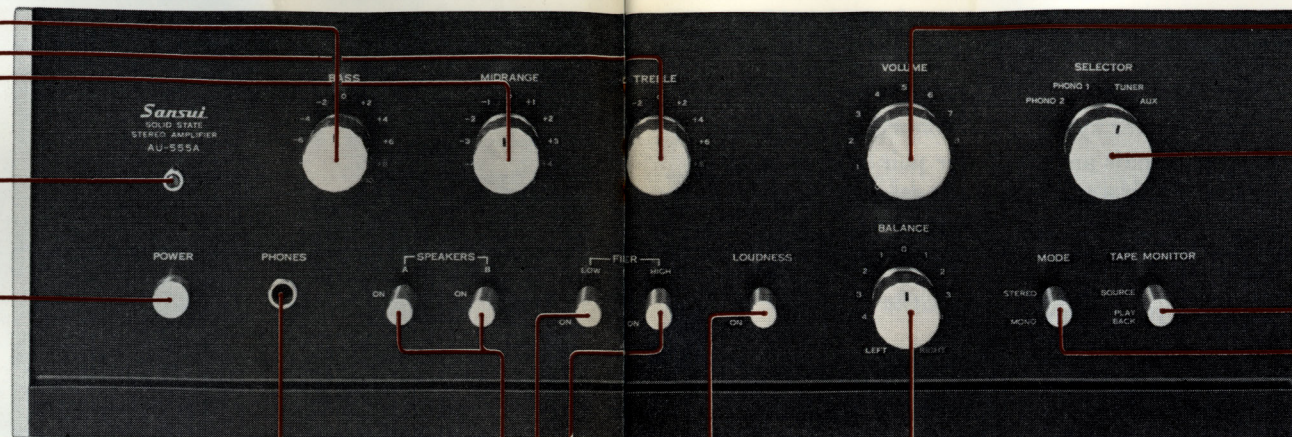

## Volume Control

The VOLUME control adjusts the over-all sound level of both channels. To increase the volume, turn the control clockwise.

## Selector Switch

This switch selects from among the various program sources connected to the input jacks on the rear panel of the amplifier. Below are the switch positions and their functions:

**PHONO 1**—Selects a record player connected to the PHONO 1 inputs on the rear panel.

**PHONO 2**—Selects a record player connected to the PHONO 2 inputs on the rear panel.

**TUNER**—Selects a tuner, or MPX adaptor connected to the TUNER inputs on the rear panel.

**AUX**—Selects a tuner, MPX adaptor or other components connected to the AUX inputs on the rear panel.

## Balance Control

This control is used to adjust for equal sound levels from both left and right channels. To increase the sound level on the right and decrease the left, turn the control clockwise. To increase the sound level on the left and decrease the right, turn the control counterclockwise.

## Loudness Switch

This switch is used to compensate for the natural hearing deficiency of the human ear in the extreme bass and treble ranges at low listening levels. When this switch is on, it converts the VOLUME control to a loudness compensated control. Switch it on to listen at low volume levels.

## Tape Monitor Switch

This switch enables you to compare the recorded tape with the original program. When the switch is in the PLAYBACK position, the recorded tape is heard from the loudspeakers. The monitoring process is only possible with a three-head tape machine. IMPORTANT: When not in use, make sure the switch is in the SOURCE position.

## Mode Switch

**STEREO**—Use this position for all stereo programs.

**MONO**—Use this position for all monophonic programs. This position connects the left or right input or the L+R program to both speakers.



# OPERATIONS

## SPEAKER CONNECTIONS

## RECORD PLAYING

### SPEAKER CONNECTIONS

Two sets of any 4- to 16-ohm speakers can be used with the AU-555A. One set may be installed as the main system, the other may be installed in any room in the house. Both systems are controlled by the SPEAKER selector switches on the front panel of the amplifier.

#### Connection

No more than 1/4-inch of insulation should be removed from the end of a speaker cable, since any greater length of exposed wire is likely to cause shorts at the terminals on the rear of the amplifier. All wire strands should be tightly twisted. As illustrated on the opposite page push the jack button down and hold with one hand, insert the end wires of the speaker cable into the hole with the other hand, and release the button.

#### One Speaker System

To connect the main set of speakers (SYSTEM-A) to the amplifier:

1. Connect the (+) terminals of the speaker on your left (as viewed from the listening position) to the LEFT SYSTEM-A (+) terminal on the rear of the amplifier.
2. Connect the lead from the common speaker terminal (marked -, C, G etc.) to the LEFT SYSTEM-A (-) terminal on the rear of the amplifier.
3. Connect the (+) terminal of the right speaker to the RIGHT SYSTEM-A (+) terminal on the rear of the amplifier.
4. Connect the lead from the common speaker terminal (marked -, C, G etc.) to the RIGHT SYSTEM-A (-) terminal on the rear of the amplifier.
5. Turn on the SPEAKER A switch.

#### Additional Speakers

If you wish to connect another set of speakers in the same room or remotely, you can connect such speakers to the SPEAKER SYSTEM-B terminals of each channel as indicated in the preceding section. In this case, turn on the SPEAKER B switch.

**Important:** If you want to use two stereo pairs of speaker systems at the same time, their impedance must be more than 8 ohms each. When one pair of 4-ohm speaker systems are connected to the SYSTEM A terminals and the other pair of 4-ohm speaker systems to the SYSTEM B taps, never use them simultaneously with both SPEAKER switches on.

### RECORD PLAYING

#### Record Player Connections

The AU-555A has two sets of PHONO inputs to accommodate a pair of players or pickup arms.

To connect a record player to the amplifier, proceed as follows:

1. Connect the left channel output of the record player to the LEFT PHONO 1 (or PHONO 2) input jack on the rear of the amplifier.
2. Connect the right channel output of the record player to the RIGHT PHONO 1 (or PHONO 2) input jack.
3. If a monophonic player or turntable is used, it may be connected to either LEFT or RIGHT PHONO input jack.

**NOTE:** A record player with a constant amplitude cartridge such as crystal or ceramic is not recommended for use with the AU-555A from a standpoint of tone quality. If such a player must be used, connect the output of the player to the AUX input jack on the rear of the amplifier.

#### Operation

1. Turn the SELECTOR switch to PHONO 1 or PHONO 2, depending on the turntable you wish to hear.
2. Set the MODE switch to STEREO. If a monophonic turntable is used, set the MODE switch to MONO.
3. Switch the turntable ON, and select the correct speed for the record to be played.
4. Place the needle on the record. When monophonic records are played on a stereo player, follow the same procedures as for stereophonic records for better results.

5. Adjust the BALANCE control to obtain equal sound from both right and left channels.
6. Use all other controls and switches according to personal taste and listening conditions.

#### Humming and Howling

Care must be taken never to place a record player on or too near a speaker enclosure. Otherwise the vibration of the speaker enclosure is transmitted to

the player and causes howling. It is best to keep these components completely separated, but if this is impossible, to place a thick cushion between them.

Humming is a phenomenon caused by incomplete or incorrect player-amplifier connections. If this occurs, check to make sure that all connections are complete and that the connecting wire is sufficiently thick.

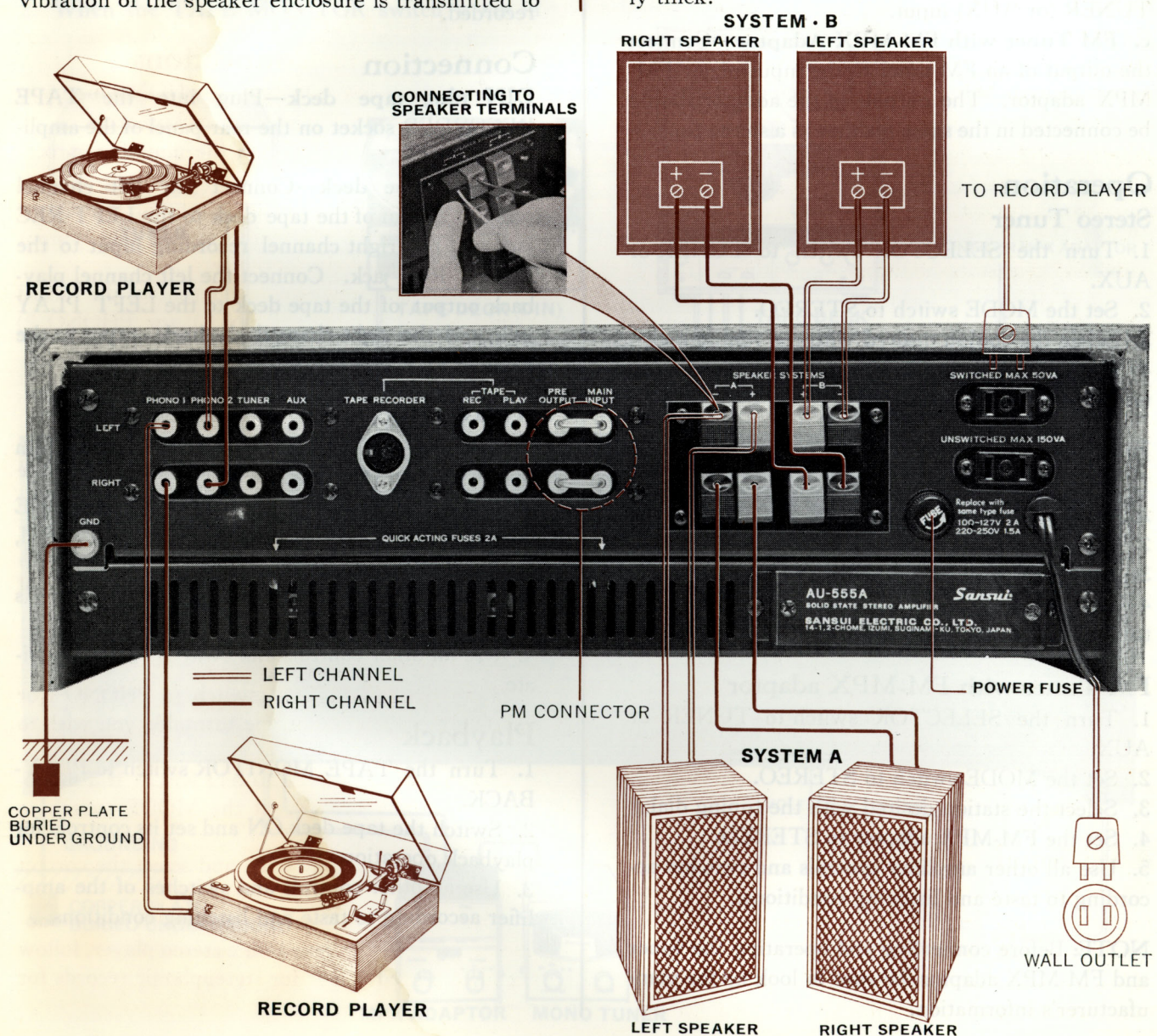



# OPERATIONS

- RADIO RECEPTIONS
- TAPE PLAYING

## RADIO RECEPTIONS

### Tuner Connections

- Stereo Tuner**—Connect the left channel output of a stereo tuner to the left channel TUNER or AUX input, and the right channel output to the right channel TUNER or AUX input.
- Monophonic Tuner**—Connect the output of a monophonic tuner to either right or left channel TUNER (or AUX) input.
- FM Tuner with FM-MPX Adaptor**—Connect the output of an FM tuner to the input of an FM-MPX adaptor. The outputs of the adaptor should be connected in the same manner as a stereo tuner.

### Operation

#### Stereo Tuner

- Turn the SELECTOR switch to TUNER or AUX.
- Set the MODE switch to STEREO.
- Select the station desired with the tuning dial.
- Use all other controls and switches according to taste and listening conditions.

#### Monophonic Tuner

- Turn the SELECTOR switch to TUNER or AUX.
- Set the MODE switch to MONO.
- Select the station desired with the tuning dial.
- Use all other controls and switches according to taste and listening conditions.

#### FM Tuner with FM-MPX adaptor

- Turn the SELECTOR switch to TUNER or AUX.
- Set the MODE switch to STEREO.
- Select the station desired with the tuning dial.
- Set the FM-MPX adaptor to STEREO.
- Use all other amplifier controls and switches according to taste and listening conditions.

**NOTE:** Before connecting and operating the tuner and FM-MPX adaptor, be sure to look up the manufacturer's information.

## TAPE PLAYING

### Tape Decks

Both DIN plug and pin jack tape decks can be connected to record from, and playback through, the amplifier. When a 3-head tape deck with separate recording and playback heads is used, the quality of tape recordings made from the amplifier can be compared with the source material while it is being recorded.

### Connection

**DIN plug tape deck**—Plug into the TAPE RECORDER socket on the rear panel of the amplifier.

**Pin-jack tape deck**—Connect the left channel recording input of the tape deck to the LEFT REC jack and the right channel recording input to the RIGHT REC jack. Connect the left channel playback output of the tape deck to the LEFT PLAY jack and the right channel playback output to the RIGHT PLAY jack.

### Recording

- Turn the SELECTOR switch to the program source to be recorded.
- If a stereo tape deck is used, set the MODE switch to STEREO. If a mono tape recorder is used, set the MODE switch to MONO.
- Switch the tape deck ON and set its controls for recording operation.
- Use all other controls and switches as appropriate.

### Playback

- Turn the TAPE MONITOR switch to PLAYBACK.
- Switch the tape deck ON and set its controls for playback operation.
- Use all other controls and switches of the amplifier according to taste and listening conditions.

## Monitoring

To monitor, proceed in the same manner as indicated in the section entitled 'Playback'.

### NOTE:

- Tape recorded sound cannot be controlled by the switches and controls on the front panel of the amplifier. They control sound from the speakers only.
- When the TAPE MONITOR switch is not in

use, make sure the switch is in the SOURCE position.

- Tape decks referred to in this section include only those with built-in playback preamplifiers.
- Tape monitoring is possible only with 3-head tape decks i.e., those with separate playback and recording heads.

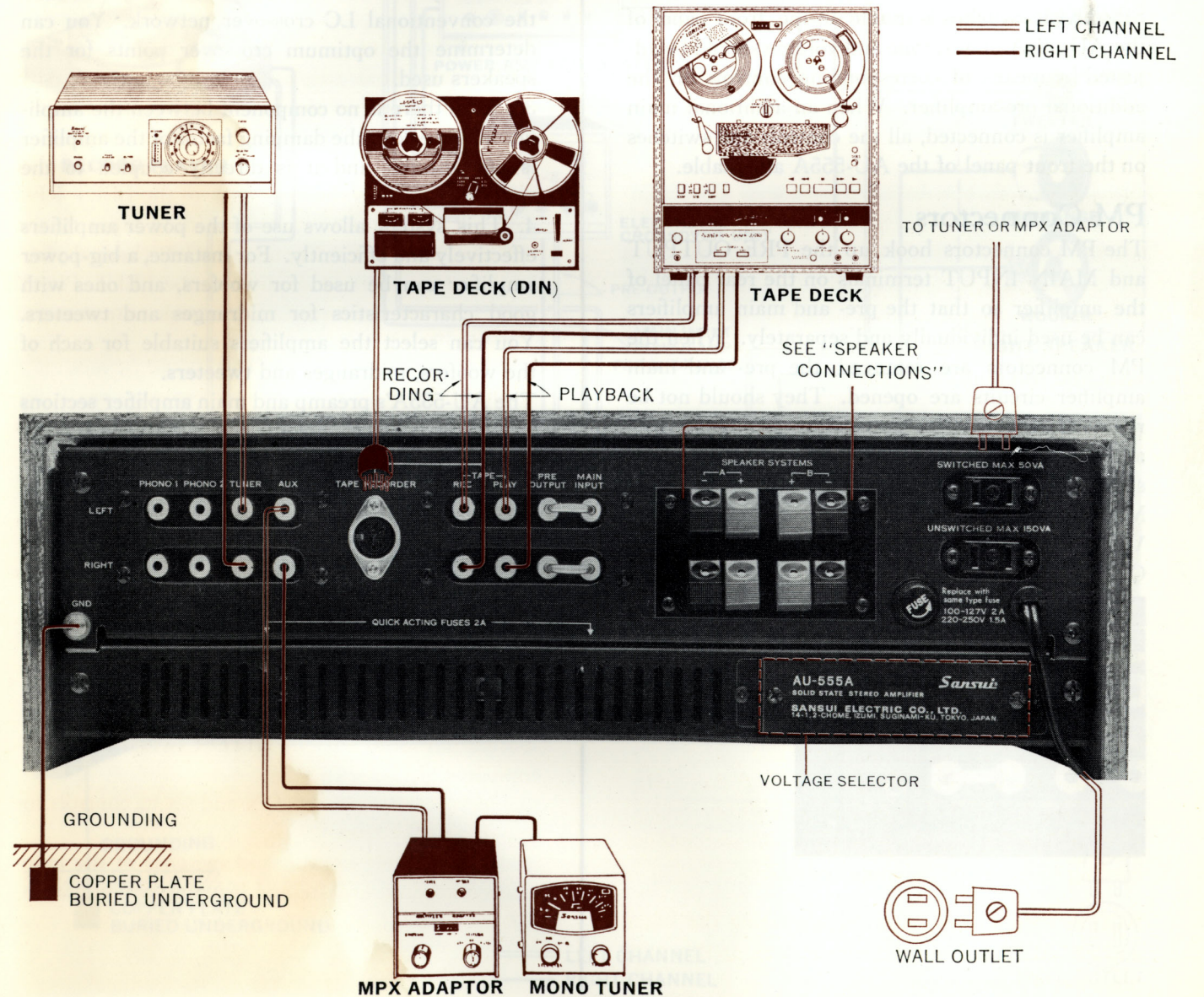



# ELECTRONIC CROSSOVER SYSTEM

## Pre-and Main Amplifiers

The AU-555A's pre- and main amplifier sections can be used independently. To use in this manner, remove the PM connectors from the jacks marked PRE OUTPUT and MAIN INPUT on the rear of the amplifier. An additional main amplifier can then be connected to the PRE OUTPUT and an additional pre-amplifier to the MAIN INPUT. When the additional pre-amplifier is connected, only the SPEAKER switches is usable on the front panel of the AU-555A. Thus, tone and volume should be adjusted by means of corresponding controls on the additional pre-amplifier. When an additional main amplifier is connected, all the controls and switches on the front panel of the AU-555A are usable.

## PM Connectors

The PM connectors hook up the PRE OUTPUT and MAIN INPUT terminals on the rear panel of the amplifier so that the pre- and main amplifiers can be used individually and separately. When the PM connectors are removed, the pre- and main amplifier circuits are opened. They should not be removed except when connecting additional pre-and/or main amplifiers for an electronic crossover system. Refer to the section titled PRE-AND MAIN AMPLIFIERS.

**Warning:** Be sure to push the POWER switch OFF before removing the PM connectors.

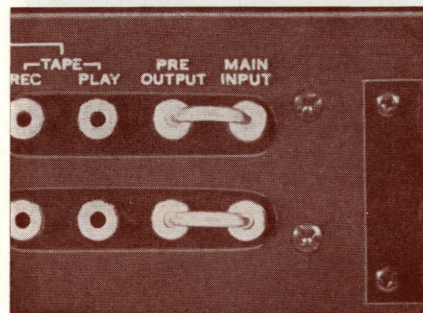

## Electronic Crossover System

The electronic crossover system is said to be the best hi-fi sound reproduction method available, featuring the following advantages:

1. Since the tweeters, midranges and woofers have their own amplifier, any speakers of different impedance and efficiency can be used for stereo arrangement.
2. This system has better filter characteristics than the conventional LC crossover network. You can determine the optimum crossover points for the speakers used.
3. Since there is no component between the amplifier and speaker, the damping factor of the amplifier is not affected and it is directly coupled to the speaker.
4. This system allows use of the power amplifiers effectively and efficiently. For instance, a big-power amplifier can be used for woofers, and ones with good characteristics for midranges and tweeters. You can select the amplifiers suitable for each of the woofers, midranges and tweeters.

The AU-555A's preamp and main amplifier sections can be used separately by simply removing a pair of connectors from the PRE OUTPUT and MAIN INPUT jacks on the rear panel. This feature enables you to use the AU-555A as a component of an Electronic Crossover System.

## AN EXAMPLE OF CONNECTIONS FOR ELECTRONIC CROSSOVER SYSTEM

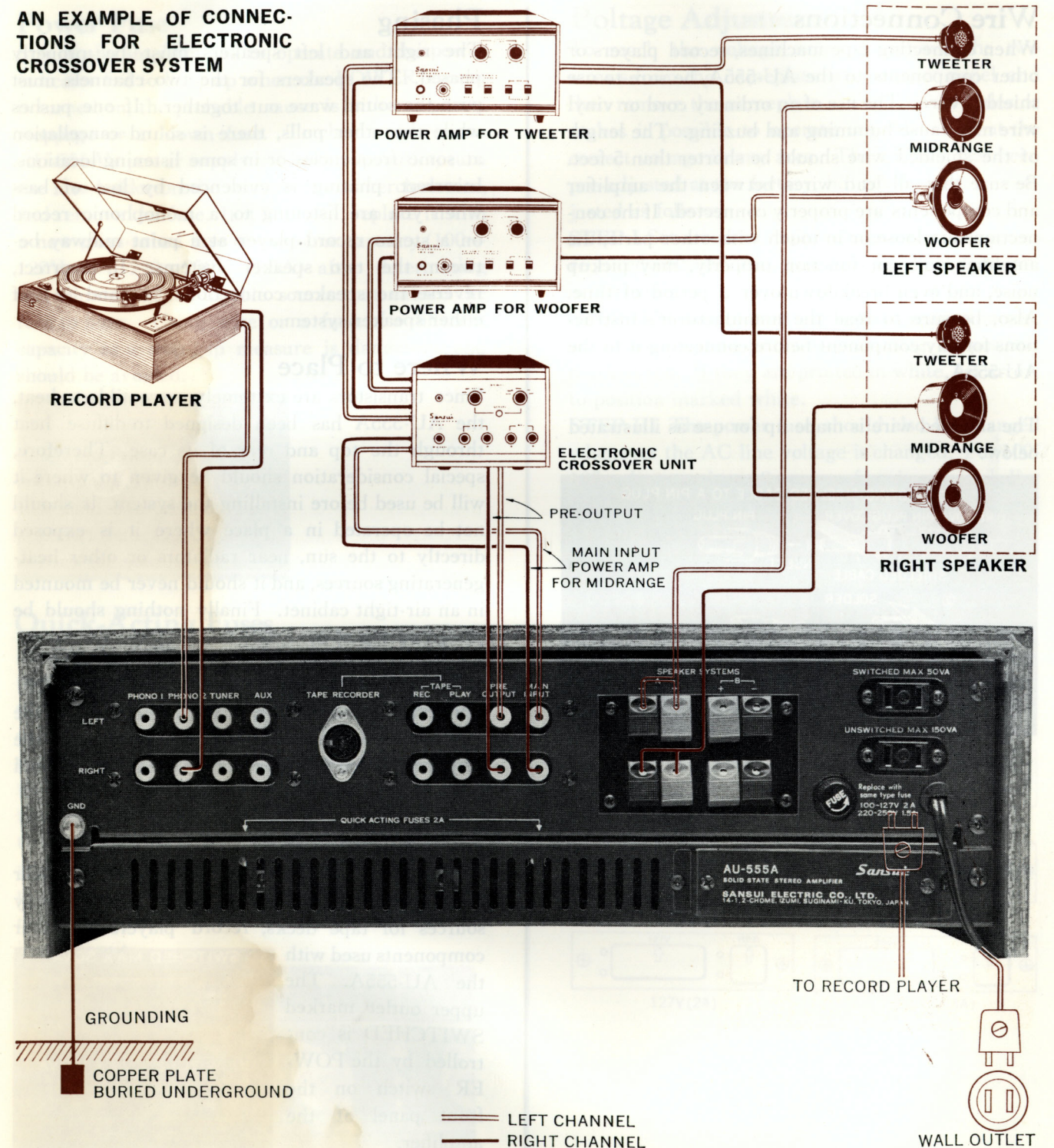



## Wire Connections

When connecting tape machines, record players or other components to the AU-555A, be sure to use shielded wire. The use of an ordinary cord or vinyl wire may cause humming and buzzing. The length of the shielded wire should be shorter than 5 feet. Be sure that all lead wires between the amplifier and components are properly connected. If the connections are loose or in touch with other parts, the amplifier will not function properly, may pickup noise, and even breakdown over a period of time. Also, be sure to read the manufacturer's instructions for any component before connecting it to the AU-555A.

The shielded wire is made up for use as illustrated below:

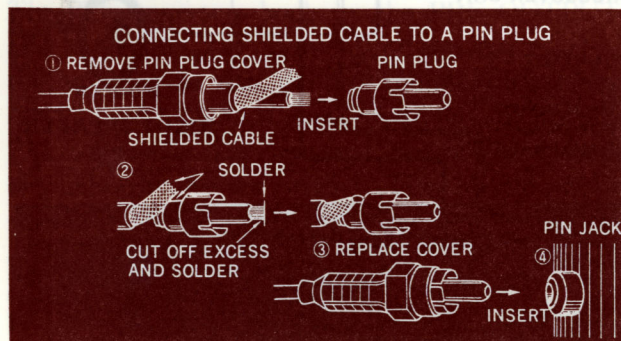

## Phasing

The right and left speakers must be properly phased. The speakers for the two channels must push the sound wave out together. If one pushes while the other pulls, there is sound cancellation at some frequencies or in some listening locations. Incorrect phasing is evidenced by loss of bass when you are listening to a monophonic record on a stereo record player at a point midway between the two speaker systems. If incorrect, reverse the speaker connections (+ and -) of either speaker system.

## Where to Place

Since transistors are extremely susceptible to heat, the AU-555A has been designed to diffuse heat through the top and rear of its case. Therefore, special consideration should be given to where it will be used before installing the system. It should not be operated in a place where it is exposed directly to the sun, near radiators or other heat-generating sources, and it should never be mounted in an air-tight cabinet. Finally nothing should be placed on top of it.

## Grounding

Connect one end of vinyl or enameled wire to the terminal screw marked GND on the rear of the amplifier, attach a copper plate to the other end, and bury it underground.

## AC Outlets

Two AC outlets have been provided on the rear panel of the amplifier to serve as power supply sources for tape decks, record players or other components used with the AU-555A. The upper outlet marked SWITCHED is controlled by the POWER switch on the front panel of the amplifier.



## Power Fuse

Should the amplifier fail to operate and the power indicator fail to light up when the POWER switch is turned on, the probable cause is either a power stoppage or a blown fuse. To check, remove the AU-555A's power supply cord from its outlet, turn the fuse holder on the rear panel counterclockwise, and remove the fuse. If it is blown, replace it with a new glass-tubed fuse of the same capacity (100~127V—2A, 220~250V—1.5A) after determining and eliminating the trouble source that caused the fuse to blow. Using wire or a fuse of a different capacity as a stop-gap measure is dangerous and should be avoided.



## Quick-Acting Fuses

If, after the POWER switch is pushed on and the power indicator lights up, neither channel operates or only one operates normally, is either because one or both quick-acting fuses have blown. In this case, remove the line cord from its a.c. outlet and remove the bottom plate from the chassis to check to see if the fuses are blown. If the fuses are faulty, replace them with identical 2A fuses (supplied) after finding and eliminating the source of trouble that caused them to blow. The trouble is probably by short at the output circuit or excessive input fed into the input circuit.

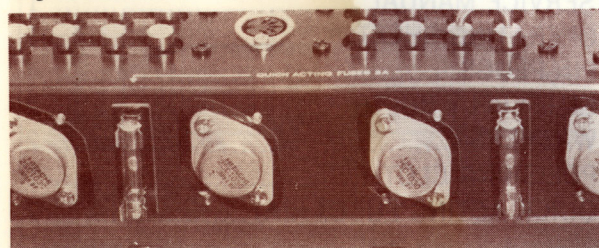

## Poltage Adjustment

To reach the voltage selector, remove the two screws from the nameplate on the rear panel and then remove the nameplate. The voltage selector makes it possible to operate the AU-555A at the correct voltage in any area. The voltage has been pre-adjusted at the factory, but can be easily readjusted as follows:

**STEP I** Set arrow of main voltage selector plug to required voltage: 100, 110, 117, 127, 220, 230, 240 or 250 volts.

**STEP II** If numerals of voltage are printed in red, set arrow of adjacent sub V.S. plug to position marked red. If they are printed in white, set arrow to position marked white.

**STEP III** The power fuse should also be changed whenever the AC line voltage is changed. For 100-127 volt operation a 2 ampere fuse is required. For 220-250 volt operation the fuse should be changed to a 1.5 ampere unit.

**NOTE:** The voltage selector can be used to eliminate the trouble caused by the considerable voltage fluctuation. In this case, it should be set to the peak voltage.

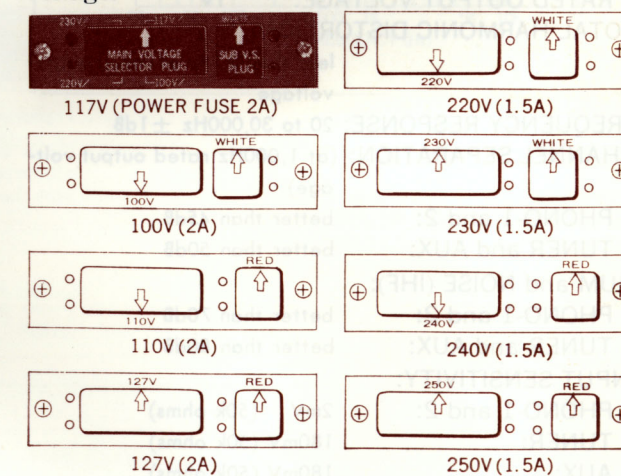



# SPECIFICATIONS / ACCESSORIES

## POWER AMPLIFIER SECTION

### POWER OUTPUT:

MUSIC POWER (IHF): 85W at 4 ohms load  
60W at 8 ohms load

CONTINUOUS POWER: 33/33W at 4 ohms load  
25/25W at 8 ohms load

### TOTAL HARMONIC DISTORTION:

less than 0.5% at rated output

### INTERMODULATION DISTORTION:

(60Hz: 7,000Hz = 4:1 SMPTE method)

less than 0.5% at rated output

### POWER BANDWIDTH (IHF):

20 to 40,000Hz

### FREQUENCY RESPONSE: (at normal listening level)

20 to 40,000Hz  $\pm 1$ dB

### CHANNEL SEPARATION: (at 1,000Hz rated output)

better than 60dB

### HUM and NOISE (IHF):

better than 100dB

### INPUT SENSITIVITY:

1V for rated output

### INPUT IMPEDANCE:

100k ohms

### LOAD IMPEDANCE:

4 to 16 ohms

### DAMPING FACTOR:

50 at 8 ohms load

## PRE-AMPLIFIER SECTION

### OUTPUT VOLTAGE

MAXIMUM OUTPUT VOLTAGE: 5V

RATED OUTPUT VOLTAGE: 1V

### TOTAL HARMONIC DISTORTION:

less than 0.1% at rated output voltage

### FREQUENCY RESPONSE: 20 to 30,000Hz $\pm 1$ dB

### CHANNEL SEPARATION: (at 1,000Hz rated output voltage)

PHONO-1 and 2: better than 45dB

TUNER and AUX: better than 50dB

### HUM and NOISE (IHF):

PHONO-1 and 2: better than 70dB

TUNER and AUX: better than 80dB

### INPUT SENSITIVITY:

PHONO-1 and 2: 2mV (50k ohms)

TUNER: 180mV (50k ohms)

AUX: 180mV (50k ohms)

TAPE PLAY (pin): 180mV (50k ohms)

TAPE RECORDER (DIN): 180mV (50k ohms)

### RECORDING OUTPUT: (at 1,000Hz rated input voltage)

TAPE REC (pin): 180mV

TAPE RECORDER (DIN): 30mV

## EQUALIZER:

### PHONO:

RIAA NF type

### CONTROLS:

#### BASS:

+12dB ~ -12dB at 30Hz

#### MIDRANGE:

+5dB ~ -5dB at 1,500Hz

#### TREBLE:

+10dB ~ -10dB at 15,000Hz

#### LOUDNESS:

+8dB at 50Hz,  
+3dB at 10,000Hz  
(volume control at -30dB)

## SWITCHES:

### LOW FILTER:

-8dB at 50Hz

### HIGH FILTER:

-7dB at 10,000Hz

### MODE:

STEREO, MONO

### TAPE MONITOR:

SOURCE, PLAYBACK

### SELECTOR:

PHONO-2, PHONO-1, TUNER,  
AUX

### SPEAKER:

A, B  
ON, OFF

## SEMICONDUCTORS:

### TRANSISTORS:

23

### DIODES:

2

## POWER REQUIREMENTS:

POWER VOLTAGE: 100, 110, 117, 127, 220, 230  
240, 250V 50/60Hz

## POWER CONSUMPTION:

130VA (max. signal)

## DIMENSIONS:

15 $\frac{9}{16}$ " (395mm)W, 5" (127mm)H,

10 $\frac{15}{16}$ " (278mm)D

## WEIGHT:

17.6 lbs. (8kg)

\*All rights reserved specifications subject to change without notice.

## ACCESSORIES LIST

1. OPERATING INSTRUCTIONS AND SERVICE MANUAL ..... 1
2. OPERATING SHEET ..... 1
3. PIN-PLUGS ..... 4
4. BUTTERFLY BOLTS ..... 2
5. WASHERS ..... 2
6. POLISHING CLOTH ..... 1
7. QUICK ACTING FUSES (2A) ..... 2

# CHARACTERISTICS

## MUSIC POWER

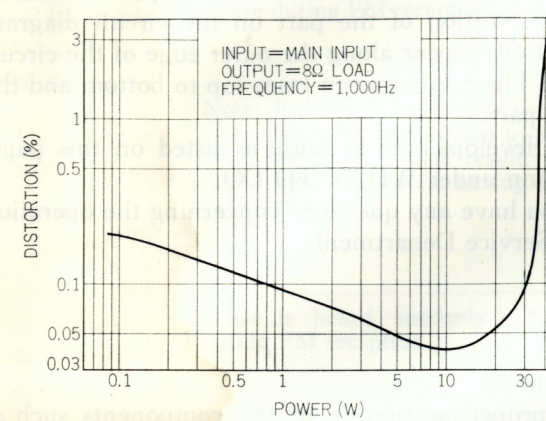

## tone control

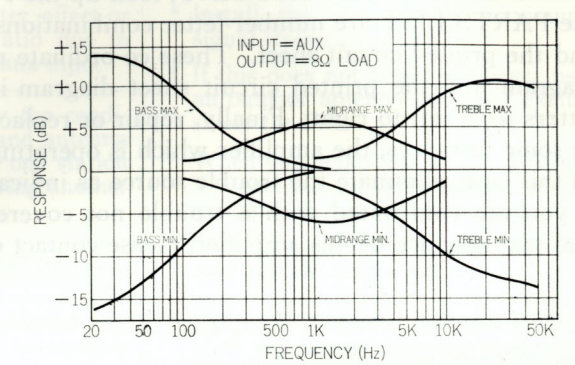

## POWER OUTPUT HARMONIC DISTORTION

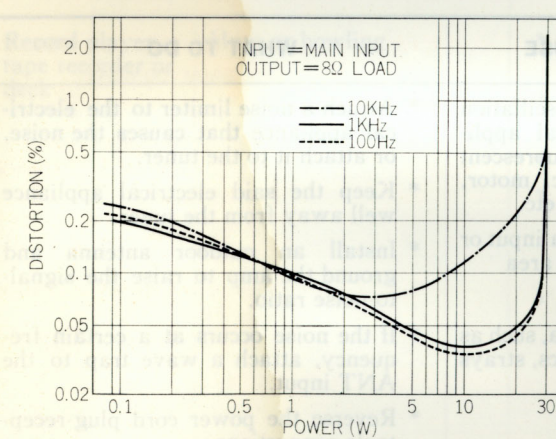

## LOW / HIGH FILTER

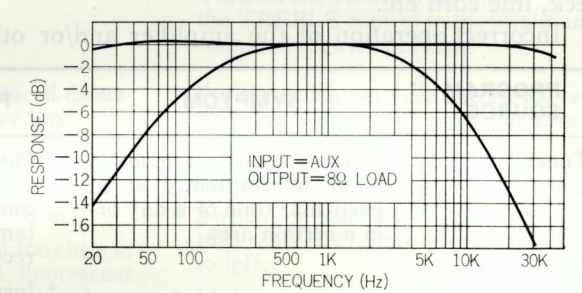

## POWER BANDWIDTH

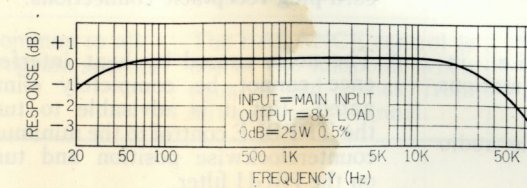



# TROUBLESHOOTING CHART

The troubleshooting charts in this manual help you isolate the cause of the trouble to a particular unit or part. If you can identify the nature of the trouble with that in these charts and can find the part number in the column under the CHECK POINT, look up the PARTS LIST on page 20~26. Following each part number in the PARTS LIST are number-letter combinations indicating the position of the part on the circuit diagram and the printed circuit sheet. These co-ordinate numbers and letters appear along the outer edge of the circuit diagram and the printed circuit sheet diagram in this manual. The numbers run from top to bottom and the letters from left to right. Finally, repair or replace the defective part.

In some instances, the amplifier which is operating satisfactorily develops hum or noise as listed on this page. In this case, eliminate the trouble source as indicated in the column under WHAT TO DO.

If you are confronted with a trouble not covered here or if you have any questions concerning the operation and maintenance of this amplifier, please contact our Customer Service Department.

If the amplifier is operating satisfactorily, the trouble may be attributed to the following:

1. Incorrect connections to or loose terminal contact with the speakers, record player, tape recorder or deck, line cord etc.
2. Incorrect operation of the amplifier and/or other

components.

3. Improper positioning of the components such as speakers and record player.
4. Defective component or copomnents connected to the amplifier.

The next step to do is listed below:

PROGRAM SOURCE	SYMPTOM	PROBABLE CAUSE	WHAT TO DO
Tuner	Noise is heard continuously or intermittently at a particular time of a day or in a certain area.	<ul style="list-style-type: none"> <li>* Discharge or oscillation caused by electrical appliances, such as fluorescent lamp, TV set, a.c. motor, rectifier, oscillator etc.</li> <li>* Insufficient antenna input or reception in fringe area</li> <li>* Wave interference</li> <li>* Natural phenomena, such as atmospherics, statics, strays and thunderbolt</li> </ul>	<ul style="list-style-type: none"> <li>* Attach a noise limiter to the electrical appliance that causes the noise, or attach it to the tuner.</li> <li>* Keep the said electrical appliance well away from the tuner.</li> <li>* Install an outdoor antenna and ground the amp to raise the signal-to-noise ratio.</li> <li>* If the noise occurs at a certain frequency, attach a wave trap to the ANT input.</li> <li>* Reverse the power cord plug-receptacle connections.</li> </ul>
	During AM reception, noise is heard at a particular time of a day, in a certain area or over part of dial.	<ul style="list-style-type: none"> <li>* Field intensity of AM signals</li> </ul>	<ul style="list-style-type: none"> <li>* Reset AM antenna for better reception</li> <li>* Ground the amp, or reverse the power cord plug-receptacle connections.</li> </ul>
	High-frequency noise is heard during AM reception.	<ul style="list-style-type: none"> <li>* Beat interference, i.e., interaction of two stations closely spaced</li> <li>* TV set close to the audio system</li> </ul>	<ul style="list-style-type: none"> <li>* The noise caused by beat interference cannot be completely eliminated. But it is advisable to turn the TREBLE control to the minimum counterclockwise position and turn on the HIGH filter.</li> <li>* Keep the TV set well away from on the audio system.</li> </ul>

PROGRAM SOURCE	SYMPTOM	PROBABLE CAUSE	WHAT TO DO
	Noise during FM reception	<ul style="list-style-type: none"> <li>* Poor noise limiter effect or too low S/N ratio due to insufficient antenna input</li> </ul>	<ul style="list-style-type: none"> <li>* Install the antenna for maximum signal strength.</li> <li>* If this does not prove effective, use an outdoor antenna designed exclusively for FM.</li> <li>* When you make use of an existing TV antenna for this purpose, attach a divider to prevent interaction.</li> <li>* Note that excessively long antenna may rather cause a noise.</li> </ul>
	Note: FM reception is affected considerably by the conditions of transmission by stations: power and antenna efficiency. As a result, you may receive one station quite well while having difficulty in receiving another station.		
	Noise is heard suddenly during FM reception.	<ul style="list-style-type: none"> <li>* Ignition noise caused by starting of an automobile engine</li> </ul>	<ul style="list-style-type: none"> <li>* Keep the antenna and its lead-in wire well away from the road side. Or raise the antenna input as described above.</li> </ul>
	Noise is heard during FM stereo reception while being not heard during FM mono.	<ul style="list-style-type: none"> <li>* The service area of FM stereo broadcast is only half as much as that of the FM mono.</li> </ul>	<ul style="list-style-type: none"> <li>* Install the antenna for maximum antenna input.</li> <li>* Turn on the HIGH filter and/or turn the TREBLE control to the minimum counterclockwise position.</li> </ul>
Record player, tape recorder or deck	Hum or howling	<ul style="list-style-type: none"> <li>* Record player placed directly on the speaker box</li> <li>* Connecting wire not shielded</li> <li>* Loose terminal contact</li> <li>* Connecting cord too close to the power cord, fluorescent lamp or other electrical appliances</li> <li>* Nearby amateur radio station or TV transmission antenna</li> </ul>	<ul style="list-style-type: none"> <li>* Put a cushion between record player and speaker box or keep them away from each other.</li> <li>* Use shielded cord.</li> <li>* Switch on the LOW filter and/or turn the BASS control from midpoint to left.</li> <li>* Make connecting cord as short as possible.</li> <li>* Connect cord tightly at terminals.</li> <li>* Keep connecting cord well away from them.</li> <li>* Consult the nearest Radio Regulatory Bureau.</li> </ul>
	Surface noise	<ul style="list-style-type: none"> <li>* Worn or old record</li> <li>* Worn or dusty pickup needle.</li> <li>* Improper needle pressure</li> </ul>	<ul style="list-style-type: none"> <li>* Turn the TREBLE control properly from mid-point to left and/or switch on the HIGH filter. Adjust the needle pressure.</li> </ul>
Common to all program sources	The BALANCE control is not at the midpoint when equal sound comes from left and right channel.	<ul style="list-style-type: none"> <li>* The BALANCE control is not always set to the midpoint depending the source materials.</li> </ul>	<ul style="list-style-type: none"> <li>* Proper balance exists when the sound seem to originate at a point midway between the speakers.</li> </ul>



# DISASSEMBLY PROCEDURE / TEST POINT

## REMOVING THE FRONT PANEL, WOOD CASE AND BOTTOM PLATE

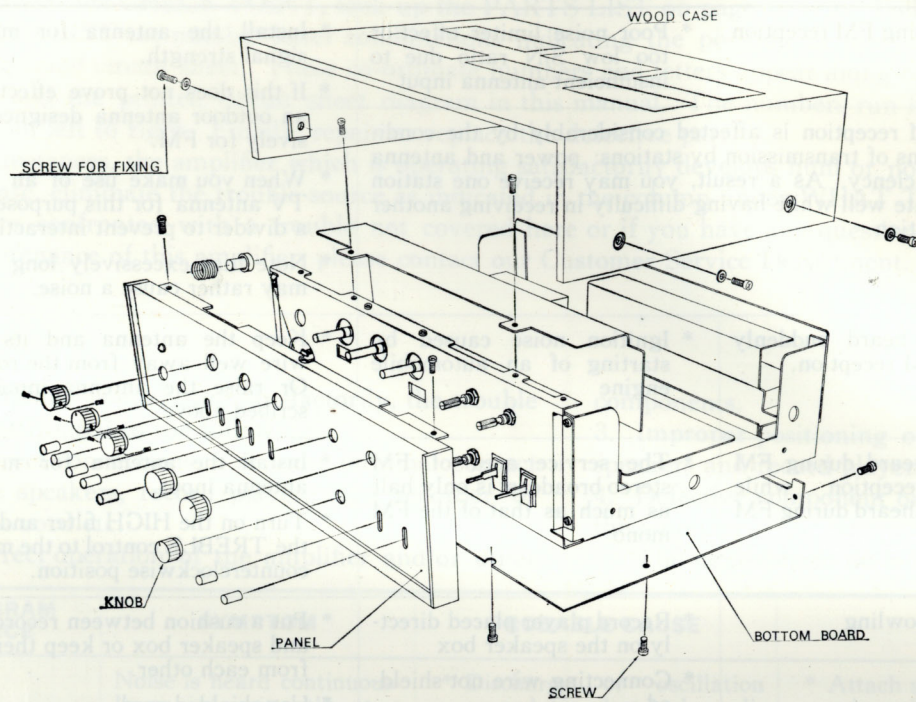

## TEST POINT

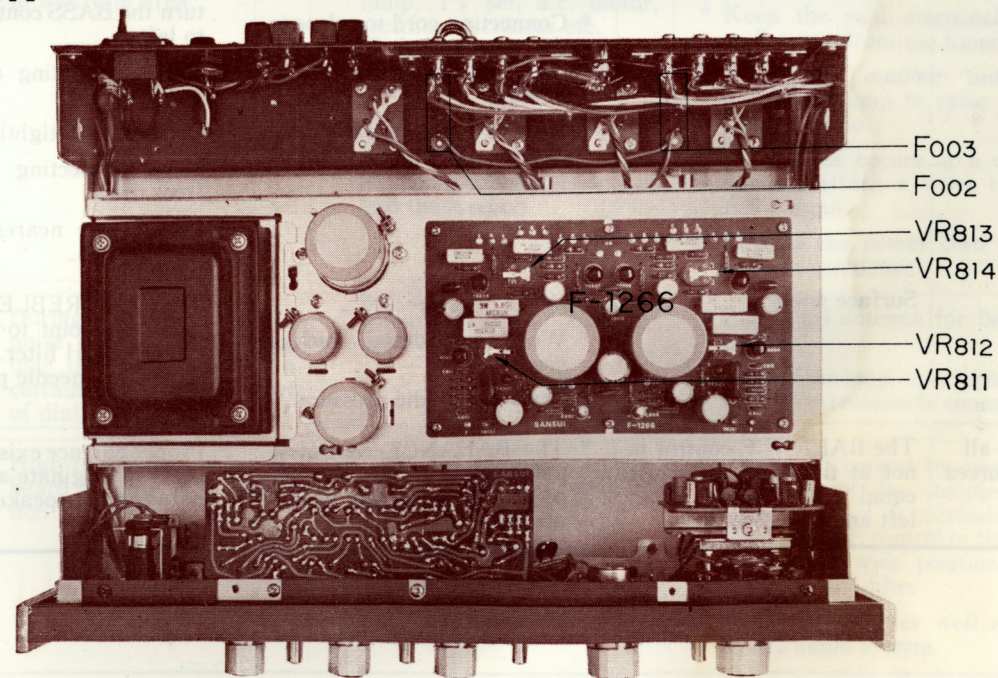

# ALIGNMENT

## MAIN-AMP SECTION OUTPUT ADJUSTMENT

STEP	CONNECTIONS & ALIGN	REMARKS
1.	Set VOLUME control to minimum.	Oscillator required: oscillation frequency of 20 to 20,000 Hz and output voltage of more than 200mV.
2.	Set oscillator to 1,000Hz and connect it to AUX of channel L.	
3.	Set SELECTOR switch to AUX	When measuring, BALANCE control to mid-position, TAPE MONITOR switch to SOURCF, MODE switch to STEREO, TONE, controls to 0 and other accessory switches to OFF position.
4.	Connect a 8-ohm (or 16-ohm) load resistor (minimum rating of 50 watts) to SYSTEM A LEFT speaker terminal.	
5.	Turn SPEAKER A switch ON.	Be sure to turn POWER switch on and then connect ammeter.
6.	Connect oscilloscope to speaker terminal.	
7.	Turn POWER switch ON; turn VOLUME control clockwise little by little; and check output at speaker terminal by using oscilloscope.	
8.	Adjust VR <sub>811</sub> so that both crests of output wave form are clipped.  For channel R, follow same procedure as above. In Step 8, adjust VR <sub>812</sub> for clipped crests of output wave.	

## MAIN-AMP SECTION CURRENT ADJUSTMENT

STEP	AMMETER (TESTER)	CONNECTIONS & ALIGN	REMARKS
1.		Remove F <sub>002</sub> and F <sub>003</sub>	Ammeter required: 100mA or 50mA range
2.		Set VR <sub>813</sub> and VR <sub>814</sub> to minimum counter-clockwise position.	
3.		Turn POWER switch ON.	Be sure to turn POWER switch on and then connect ammeter.
4.	Set to 100mA range.	Set ammeter in place of F <sub>002</sub> . Connect its ⊕ terminal to B <sub>1</sub> , and its ⊖ terminal to B <sub>2</sub> in schematic diagram.	
5.		Turn VR <sub>813</sub> and adjust current to 20mA	Turn POWER switch OFF and reset F <sub>002</sub> to its original position.
6.		Turn POWER switch OFF and reset F <sub>002</sub> to its original position.	
7.	Set to 100mA range.	Turn POWER switch ON and set ammeter in place of F <sub>003</sub> . Connect its ⊕ terminal to B <sub>1</sub> , and its ⊖ terminal B <sub>3</sub> in schematic diagram.	Turn VR <sub>814</sub> and adjust current to 20mA
8.		Turn VR <sub>814</sub> and adjust current to 20mA	



# BLOCK DIAGRAM

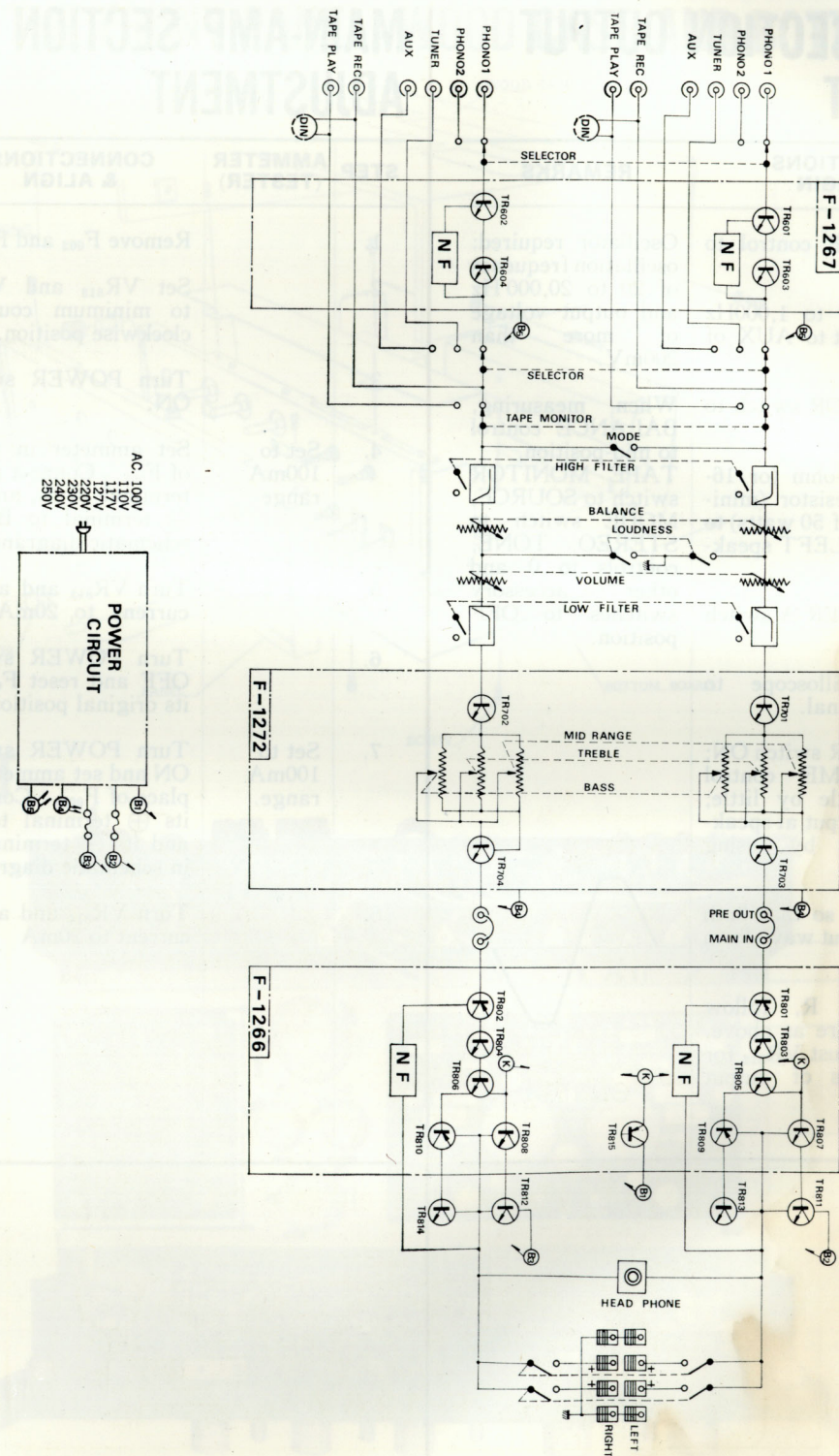

# PRINTED CIRCUIT BOARDS AND PARTS LIST

X: Parts No. Y: Parts Name Z: Position of Parts

## EQUALIZER <F-1267>

X	Y	Z
R601	2.2k $\Omega$	2B
R602	2.2k $\Omega$	2A
R603	56k $\Omega$	2B
R604	56k $\Omega$	2A
R605	390k $\Omega$	2B
R606	390k $\Omega$	2A
R607	3.9k $\Omega$	2B
R608	3.9k $\Omega$	2A
R609	330 $\Omega$	1B
R610	330 $\Omega$	1A
R611	180k $\Omega$	1B
R612	180k $\Omega$	1A
R613	820 $\Omega$	1B
R614	820 $\Omega$	1A
R615	6.8k $\Omega$	1B
R616	6.8k $\Omega$	1A
R617	82k $\Omega$	2B
R618	82k $\Omega$	2A
R619	330k $\Omega$	1B
R620	330k $\Omega$	1A
R621	1.5k $\Omega$	1B
R622	1.5k $\Omega$	1A
R623	22k $\Omega$	1B
R624	22k $\Omega$	1A

±10% 1/4W Carbon Resistor

X	Y	Z
C601	0.33 $\mu$ F	2B
C602	0.33 $\mu$ F	2A
C603	68 pF	2B
C604	68 pF	2A
C605	68 pF	1B
C606	68 pF	1A
C607	3.3 $\mu$ F	2B
C608	3.3 $\mu$ F	2A
C609	100 $\mu$ F	2B
C610	100 $\mu$ F	2A
C611	1 $\mu$ F	1B
C612	1 $\mu$ F	1A
C613	0.01 $\mu$ F	1B
C614	0.01 $\mu$ F	1A
C615	0.003 $\mu$ F	1B
C616	0.003 $\mu$ F	1A
C617	0.047 $\mu$ F	1B
C618	0.047 $\mu$ F	1A
TR601	2SC871R(E,F)	2B
TR602	2SC871R(E,F)	2A
TR603	2SC871R(F)	2B
TR604	2SC871R(F)	2A

±10% 50 WV Mylar Capacitor

±10% 25 WV Ceramic Capacitor

25 WV } Electrolytic Capacitor

6.3 WV } Electrolytic Capacitor

50 WV } Electrolytic Capacitor

(030547-4,-5)

(030547-5)

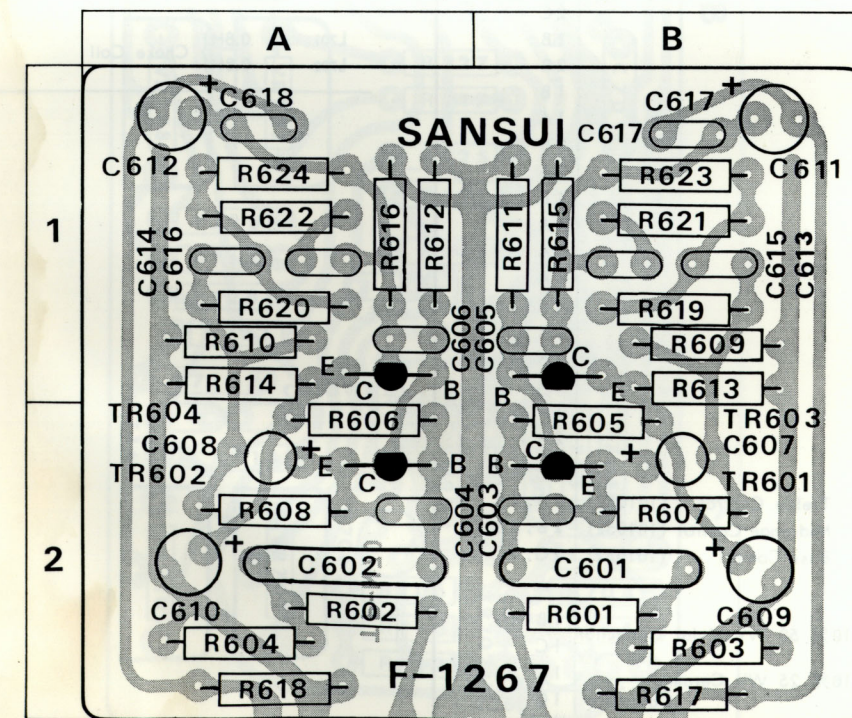



# PRINTED CIRCUIT BOARDS AND PARTS LIST

X: Parts No. Y: Parts Name Z: Position of Parts

## tone control <F-1272>

X	Y	Z
R701	330kΩ	1B
R702	330kΩ	1B
R703	2.2kΩ	1B
R704	2.2kΩ	1B
R705	82kΩ	1C
R706	82kΩ	1C
R707	560kΩ	1B
R708	560kΩ	1C
R709	560Ω	1C
R710	560Ω	1C
R711	1kΩ	1C
R712	1kΩ	1C
R713	4.7kΩ	1C
R714	4.7kΩ	1C
R715	10kΩ	1C
R716	10kΩ	1C
R717	10kΩ	2B
R718	10kΩ	1B
R719	2.7kΩ	2B
R720	2.7kΩ	1C
R721	22kΩ	2B
R722	22kΩ	1C
R723	5.6kΩ	2B
R724	5.6kΩ	2A
R725	10kΩ	1B
R726	10kΩ	2C
R727	10kΩ	1B
R728	10kΩ	2B
R729	10kΩ	1B
R730	10kΩ	1A
R731	2.2kΩ	2B
R732	2.2kΩ	2A
R733	100kΩ	1B
R734	100kΩ	1A
R735	270kΩ	1A
R736	270kΩ	1A
R737	3.3kΩ	1A
R738	3.3kΩ	1A
R739	5.6kΩ	1A
R740	5.6kΩ	1A
R741	82kΩ	1B
R742	82kΩ	2A
VR705,706	100kΩ(B)×2 Treble Control (101052)	2A, 2B
VR707,708	100kΩ(B)×2 Midrange Control (101052)	2B, 2B
VR709,710	100kΩ(B)×2 Bass Control (101052)	2C, 2C
C701	0.22μF } ±10% 50 WV Mylar Capacitor	1B
C702	0.22μF }	1C
C703	10pF } ±10% 25 WV Ceramic Capacitor	1C
C704	10pF }	1C

X	Y	Z
C705	47μF 6.3 WV	1C
C706	47μF 6.3 WV	1C
C707	10μF RN 25 WV	1B, C
C708	10μF RN 25 WV	1C
C709	0.033μF } ±10% 50 WV Mylar Capacitor	1C
C710	0.033μF }	2C
C711	0.002μF	2B
C712	0.002μF	2A
C713	0.008μF	2B
C714	0.008μF	2B
C715	0.033μF	1, 2C
C716	0.033μF	2C
C717	1μF RN 50 WV	1B
C718	1μF RN 50 WV	1A
C721	47μF 10 WV	1A
C722	47μF 10 WV	1A
C723	10μF RN 25 WV	1B
C724	10μF RN 25 WV	1A
C725	0.047μF } ±10% 50 WV Mylar Capacitor	1C
C726	0.047μF }	1C
TR701	2SC871R(E,F) } (030547-4,-5)	1C
TR702	2SC871R(E,F) }	1C
TR703	2SC871R(E,F) } (030547-4,-5)	1A
TR704	2SC871R(E,F) }	1A
L701	0.8H } Choke Coil (401003)	2B
L702	0.8H }	2A

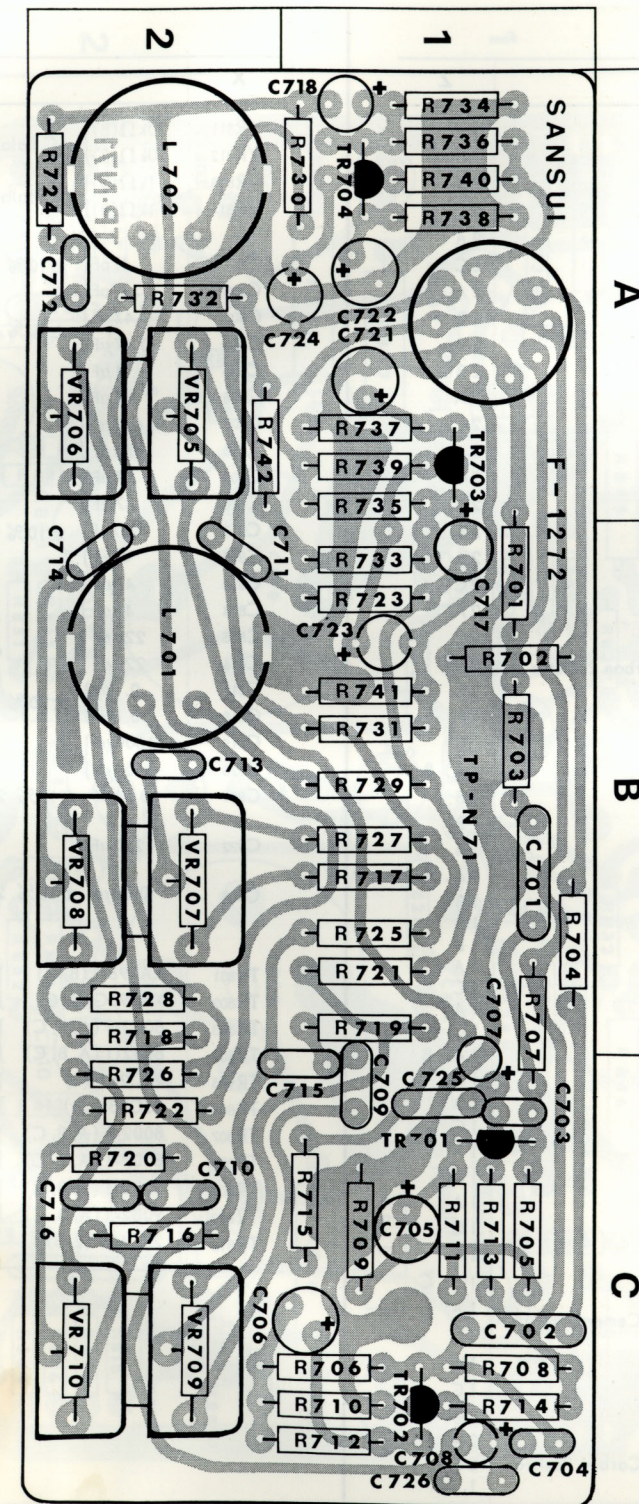



# PRINTED CIRCUIT BOARDS AND PARTS LIST

X: Parts No. Y: Parts Name Z: Position of Parts

## MAIN AMP <F-1266>

X	Y	Z
R801	10kΩ	2A
R802	10kΩ	2C
R803	470kΩ	2A
R804	470kΩ	2C
R805	150kΩ	2A
R806	150kΩ	2C
R807	560kΩ	2A, B
R808	560kΩ	2B
R809	560kΩ	2B
R810	560kΩ	2B
R811	150Ω	2A
R812	150Ω	2C
R813	4.7kΩ	2A
R814	4.7kΩ	2C
R815	5.6kΩ	2B
R816	5.6kΩ	2B
R817	1kΩ	2A
R818	1kΩ	2C
R819	1kΩ	2A
R820	1kΩ	2C
R821	220Ω	±10% 1/4W Carbon Resistor
R822	220Ω	2C
R823	1kΩ	1A
R824	1kΩ	1C
R825	3.3kΩ	1A, B
R826	3.3kΩ	1B
R827	1kΩ	1B
R828	1kΩ	1B
R829	3.9kΩ	1A, B
R830	3.9kΩ	1B
R831	39Ω	1B
R832	39Ω	1A
R833	150Ω	1C
R834	150Ω	1A
R835	27Ω	1C
R836	27Ω	1A, B
R837	150Ω	1B
R838	150Ω	1A
R839	6.8Ω	1C
R840	6.8Ω	1B
R841	6.8Ω	1B
R842	6.8Ω	1A
R843	0.5Ω	1C
R844	0.5Ω	1A
R845	0.5Ω	±20% 2W
R846	0.5Ω	1B, C
R847	6.8Ω	1A
R848	6.8Ω	±10% 3W
R849	150Ω	1C
R850	150Ω	±10% 5W
R851	5.6kΩ	2B
R852	5.6kΩ	±10% 1/4W
R853	15kΩ	2B

X	Y	Z
VR811	20kΩ(B)	AC Balance Adjustment (103046-2)
VR812	20kΩ(B)	2C
VR813	1kΩ(B)	DC Balance Adjustment (103059)
VR814	1kΩ(B)	1C
C801	47pF	±10% 25WV Ceramic Capacitor
C802	47pF	2C
C803	0.47μF	±10% 50WV Mylar Capacitor
C804	0.47μF	2C
C805	1μF	50WV
C806	1μF	2B
C807	470μF	16WV Electrolytic Capacitor
C808	470μF	2C
C809	47μF	25WV
C810	47μF	2A, C
C811	47pF	±10% 25WV Ceramic Capacitor
C812	47pF	2C
C813	47μF	50WV
C814	47μF	1B
C815	220μF	6.3WV Electrolytic Capacitor
C816	220μF	1C
C817	0.1μF	±10% 50WV Mylar Capacitor
C818	0.1μF	1C
C819	1500μF	63WV Electrolytic Capacitor (020537)
C820	1500μF	1, 2A B
C821	0.01μF	±10% 250WV Ceramic Capacitor
C822	220μF	75WV Electrolytic Capacitor
C823	0.01μF	±10% 250WV Ceramic Capacitor
C824	0.01μF	1B
TR801	XA495G (B, C)	(030017-1, -2)
TR802	XA495G (B, C)	2A
TR803	8002-1 (A, B, C)	(030555, -1, -2)
TR804	8002-1 (A, B, C)	2A
TR805	2SC281 (B)	(030512-1)
TR806	2SC281 (B)	2C
TR807	8002-1 (A, B, C)	1A
TR808	8002-1 (A, B, C)	1B, C
TR809	9002-1 (A, B, C)	1B
TR810	9002-1 (A, B, C)	(030014, -1, -2)
TR811	2SC627 (2, 3)	1A
TR812		1C
TR813		1B
TR814		1B
TR815		1C
TR816		1B
TR817		1C
TR818		1A
TR819		1C
TR820		1B
TR821		1C
TR822		1B
TR823		1C
TR824		1A
TR825		1C
TR826		1B
TR827		1C
TR828		1B
TR829		1C
TR830		1B
TR831		1C
TR832		1B
TR833		1C
TR834		1B
TR835		1C
TR836		1B
TR837		1C
TR838		1B
TR839		1C
TR840		1B
TR841		1C
TR842		1B
TR843		1C
TR844		1B
TR845		1C
TR846		1B
TR847		1C
TR848		1B
TR849		1C
TR850		1B
TR851		1C
TR852		1B
TR853		1C

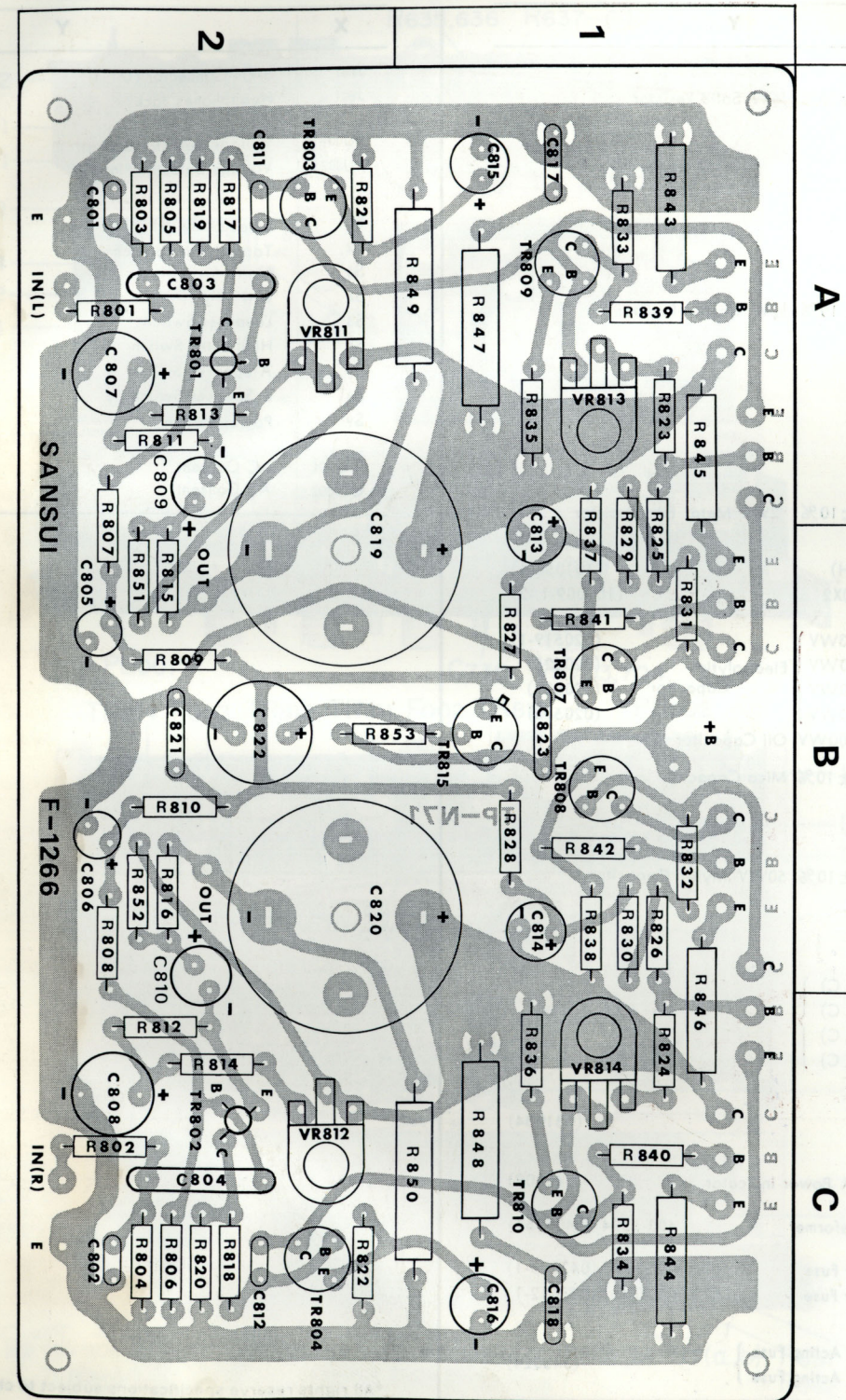



# OTHER PARTS AND THEIR POSITION ON CHASSIS

X: Parts No. Y: Parts Name

X	Y	X	Y	
R001	1.2k $\Omega$	J601	5-Pin Connector (DIN) (243004)	
R002	1k $\Omega$	J801	Headphones Jack (243007-1)	
R003	1k $\Omega$	PU001	Voltage Selector Socket (241017)	
R635	470k $\Omega$	PU002	Voltage Selector Plug (241018)	
R636	470k $\Omega$		(241019)	
R637	180k $\Omega$	S1	Selector Switch Y-2-4-4 (110217)	
R638	180k $\Omega$	S2	Tape Monitor Switch	
R639	100k $\Omega$	S3	Mode Switch	
R640	100k $\Omega$	S4	Low Filter Switch	
R751	10k $\Omega$	S5	Loudness Switch	
R752	10k $\Omega$	S6	High Filter Switch	
R753	27k $\Omega$	S7	A Speaker Switch	
R754	27k $\Omega$	S8	B Speaker Switch	
R755	820k $\Omega$	S9	Power Switch (113016)	
R756	820k $\Omega$	CO001	AC Consent (245001)	
R757	820k $\Omega$	CO002	AC Consent (245001)	
R758	820k $\Omega$			
R861	470 $\Omega$			
R862	470 $\Omega$			
VR701, 702	250k $\Omega$ (BH)		(101050-1)	
VR703, 704	250k $\Omega$ (B)X2		(101009-1,-2)	
C001	2200 $\mu$ F 63WV		(020519-1)	
C002	470 $\mu$ F 50WV	Electrolytic Capacitor	(020525)	
C003	1000 $\mu$ F 50WV		(020539)	
C004	470 $\mu$ F 50WV		(020525)	
C005	0.033 $\mu$ F 600WV		Oil Capacitor	
C735	150pF	$\pm 10\%$ Mica Capacitor		
C736	150pF			
C737	0.02 $\mu$ F			
C738	0.02 $\mu$ F			
C739	0.01 $\mu$ F		$\pm 10\%$ 50WV Mylar Capacitor	
C740	0.01 $\mu$ F			
C741	0.0033 $\mu$ F			
C742	0.0033 $\mu$ F			
TR811	2SC1030 (B, C)			(030563-1, -2)
TR812	2SC1030 (B, C)			
TR813	2SC1030 (B, C)			
TR814	2SC1030 (B, C)			
D001	10D-1	(031034)		
D002	10D-1			
PL001	6.3V 250mA Power Indicator	(040009)		
T001	Power Transformer	400-5394 (400064)		
F001	2A Power Fuse	(100~127V) (043003-1)		
	1.5A Power Fuse	(220~250V) (043012-1)		
F002	2A Quick Acting Fuse	(043024)		
F003	2A Quick Acting Fuse			

\*All rights reserve specifications subject to change without notice.

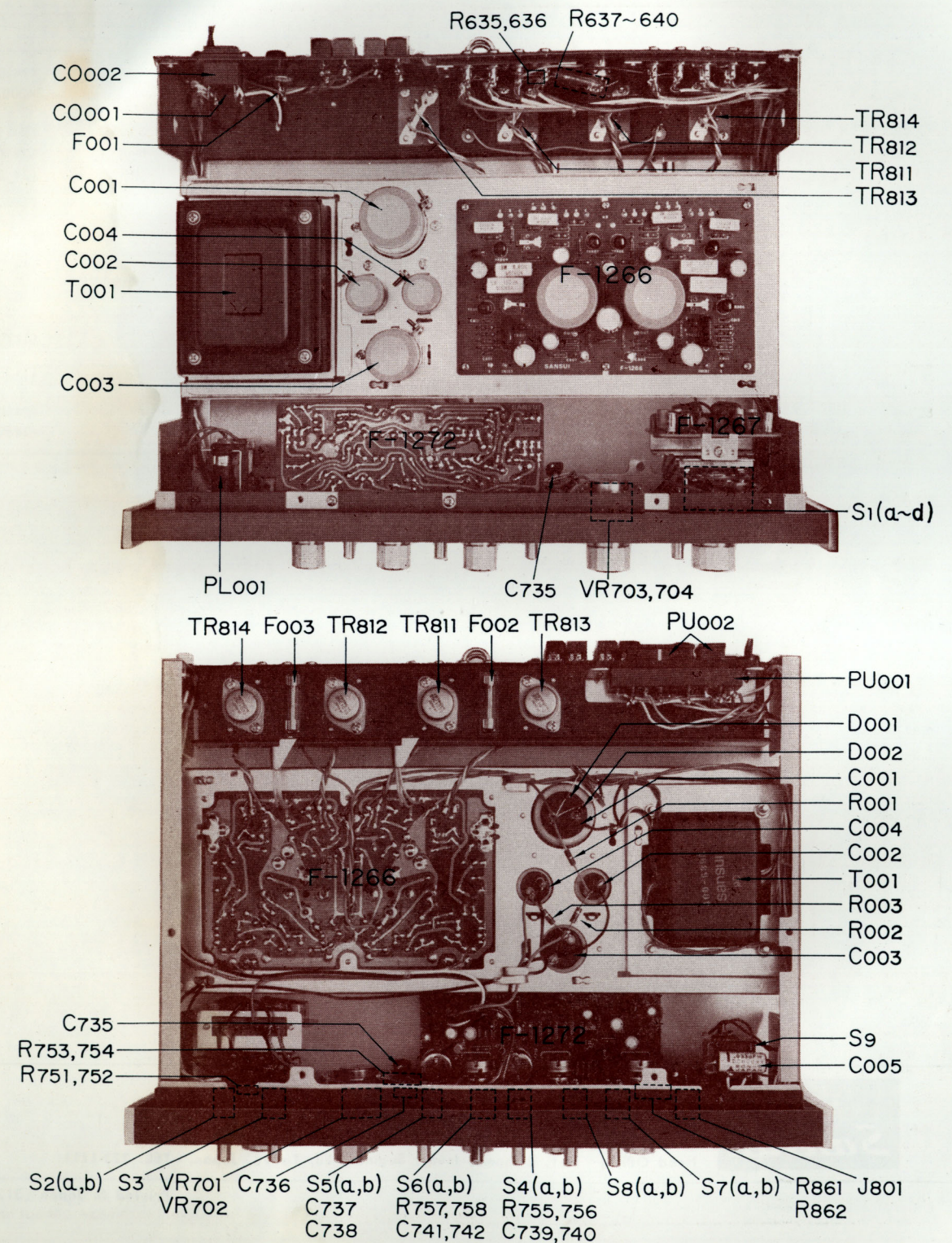





**SANSUI ELECTRIC COMPANY LIMITED**

Head Office; 14-1, 2-chome, Izumi, Suginami-ku, Tokyo, Japan. TEL. 323-1111

Printed in Japan (31200M6)



# SANSUI AU-555A SCHEMATIC DIAGRAM

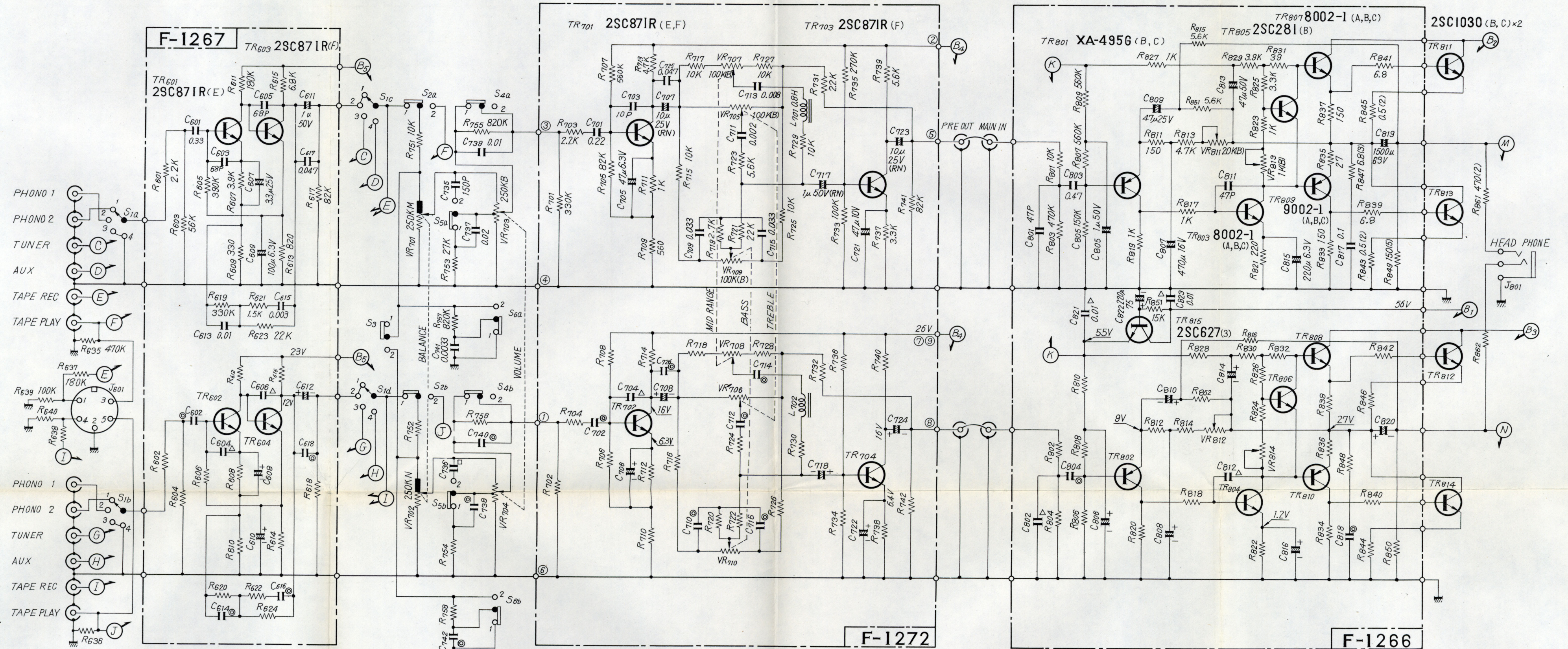

**SYMBOL**  
 ○ OIL  
 □ MICA  
 ● MYLAR  
 △ CERAMIC

**ALL RESISTORS 1/4 WATT UNLESS OTHERWISE NOTED.**

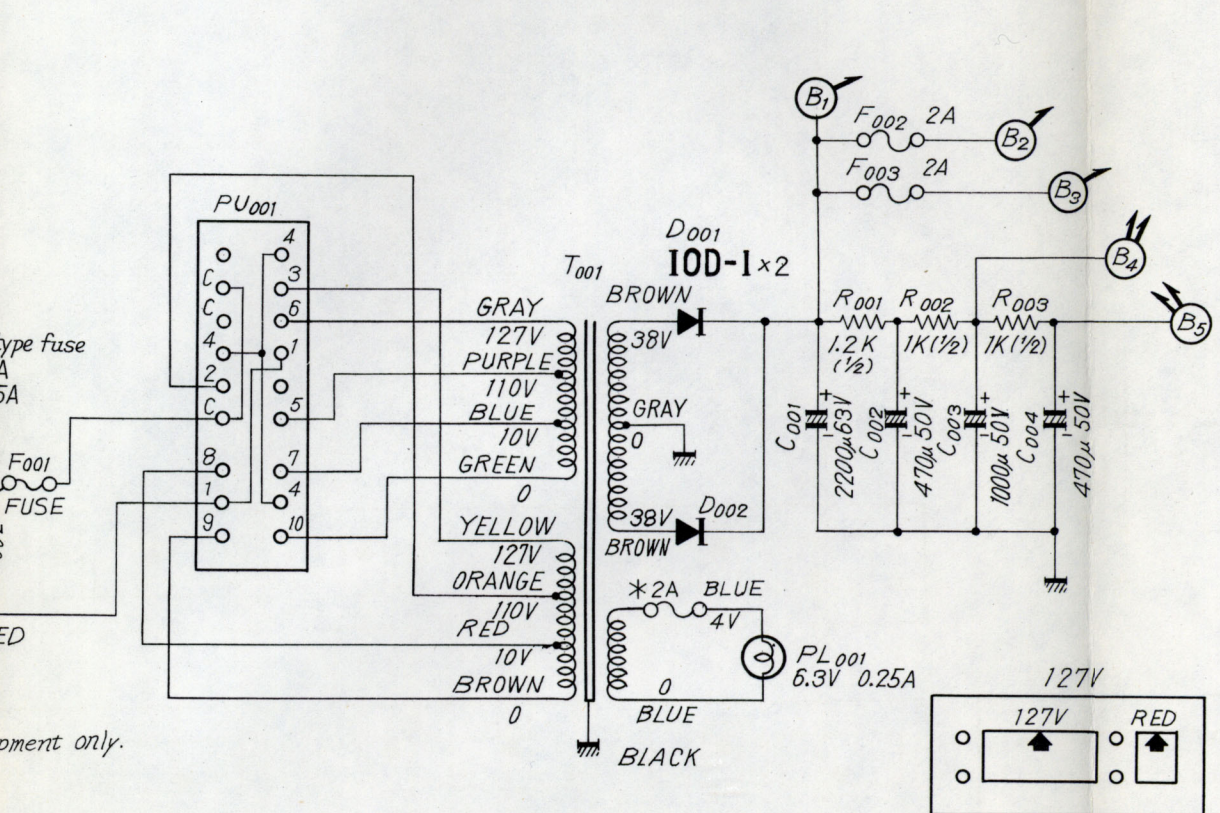
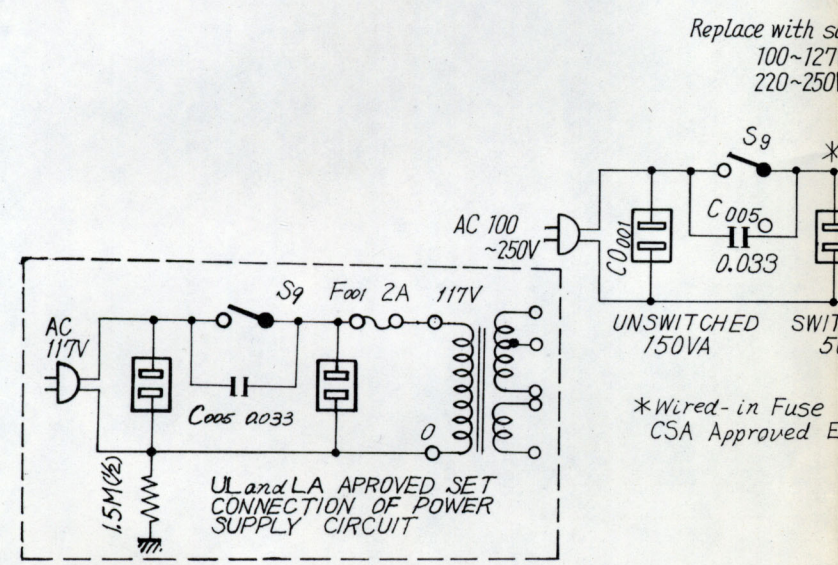

- S1(a~d) SELECTOR SW  
 1. PHONO 2  
 2. PHONO 1  
 3. TUNER  
 4. AUX
- S2(a,b) TAPE MONITOR SW  
 1. SOURCE  
 2. PLAY BACK
- S3 MODE SW  
 1. STEREO  
 2. MONO
- S4(a,b) LOW FILTER SW  
 1. OFF  
 2. ON
- S5(a,b) LOUDNESS SW  
 1. OFF  
 2. ON
- S6(a,b) HIGH FILTER SW  
 1. OFF  
 2. ON
- S7(a,b) A SPEAKERS SW  
 1. ON  
 2. OFF
- S8(a,b) B SPEAKERS SW  
 1. ON  
 2. OFF
- S9 POWER SW  
 1. OFF  
 2. ON

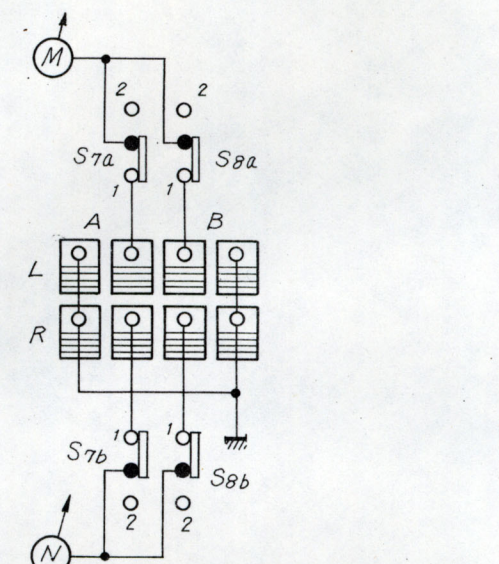

\* Manufacturer reserves right to change design and/or specifications without notice for purpose of improvement.